

TOP VIEW

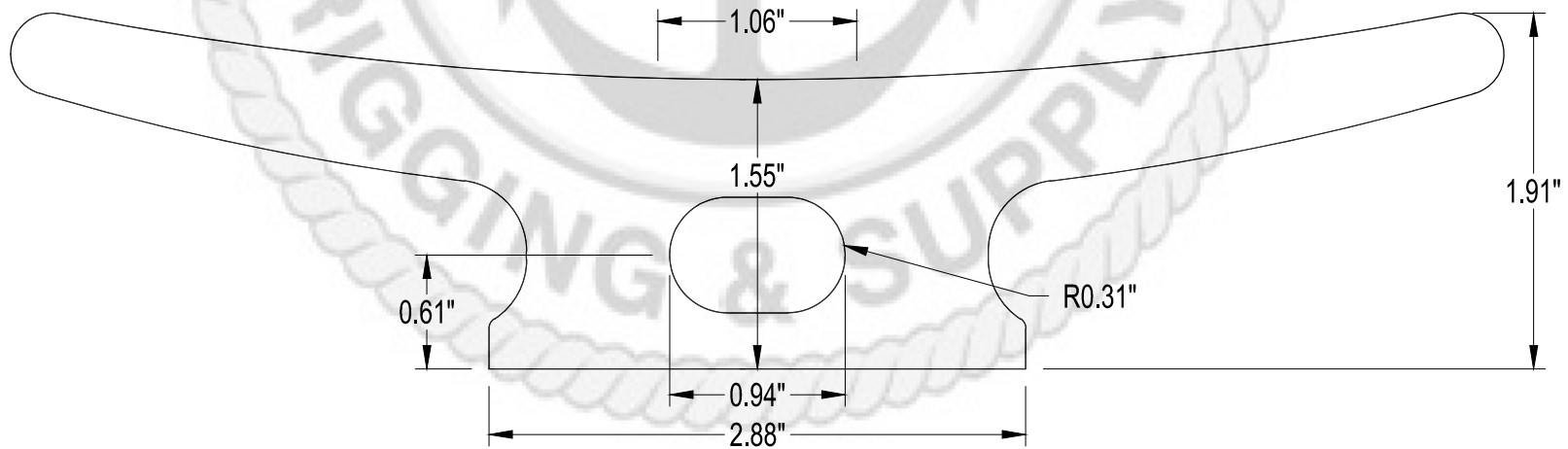

SIDE VIEW

PROPRIETARY AND CONFIDENTIAL THE INFORMATION CONTAINED IN THIS DRAWING IS THE SOLE PROPERTY OF ACE MARINE. ANY REPRODUCTION IN PART OR AS A WHOLE WITHOUT THE WRITTEN PERMISSION OF ACE MARINE IS PROHIBITED. SCALE: 1:1 DATE: 8-30-11 DRAWN BY: DWG	ACE MARINE RIGGING & SUPPLY, INC 600 ARENDELL STREET MOREHEAD CITY, NC 28557 PHONE (252)726-6620 FAX (252)726-7499	DESCRIPTION 8" CLEAT	
		PART NO. AMC-8-1	
		MATERIAL MAL. IRON - GRADE 32510	SHEET SIZE A